

MAZWxxxHG Series

Silicon planar type

For surge absorption circuit

■ Features

- Two elements anode-common type

■ Absolute Maximum Ratings $T_a = 25^\circ\text{C}$

Parameter	Symbol	Rating	Unit
Total power dissipation *	P_{tot}	150	mW
Junction temperature	T_j	150	$^\circ\text{C}$
Storage temperature	T_{stg}	-55 to +150	$^\circ\text{C}$

Note) *: $P_{\text{tot}} = 150$ mW achieved with a printed circuit board.

■ Package

- Code
SSSMini3-F2
- Pin Name
1: Cathode 1
2: Cathode 2
3: Anode 1, 2

■ Internal Connection

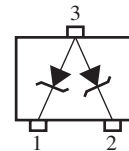

■ Common Electrical Characteristics $T_a = 25^\circ\text{C} \pm 3^\circ\text{C}$

Parameter	Symbol	Conditions	Min	Typ	Max	Unit
Zener voltage *	V_Z	I_Z Specified value				V
Zener rise operating resistance	R_{ZK}	I_Z Specified value				Ω
Zener operating resistance	R_Z	I_Z Specified value				Ω
Reverse current	I_R	V_R Specified value				μA

Refer to the list of the electrical characteristics within part numbers

Note) 1. Measuring methods are based JAPANESE INDUSTRIAL STANDARD JIS C 7031 measuring methods for diodes.

2. Electrostatic breakdown voltage is ± 10 kV

Test method: IEC1000-4-2 (C = 150 pF, R = 330 Ω , Contact discharge: 10 times)

3. *: The temperature must be controlled 25°C for V_Z measurement.

V_Z value measured at other temperature must be adjusted to $V_Z (25^\circ\text{C})$

V_Z guaranteed 20 ms after current flow.

■ Electrical characteristics within part numbers $T_a = 25^\circ\text{C} \pm 3^\circ\text{C}$

Part number	Zener voltage				Reverse current (DC)		Zener operating resistance		Marking symbol
	V_Z (V)				I_R (μA)		R_Z (Ω)	R_{ZK} (Ω)	
	Min	Nom	Max	I_Z (mA)	Max	V_R (V)	$I_Z = 5 \text{ mA}$ Max	$I_Z = 0.5 \text{ mA}$ Max	
MAZW062HG	5.8	6.2	6.6	5	0.2	4	50	100	62
MAZW068HG	6.4	6.8	7.2	5	0.1	4	30	60	68
MAZW082HG	7.7	8.2	8.7	5	0.1	5	30	60	82
MAZW100HG	9.4	10.0	10.6	5	0.05	7	30	60	10
MAZW120HG	11.4	12.0	12.7	5	0.05	9	30	60	12

- Note) 1. The V_Z value is the one after power application for 20 ms at $T_a = 25^\circ\text{C}$.
 2. The zener voltage temperature coefficient is the one for $T_j = 25^\circ\text{C}$ to 150°C .

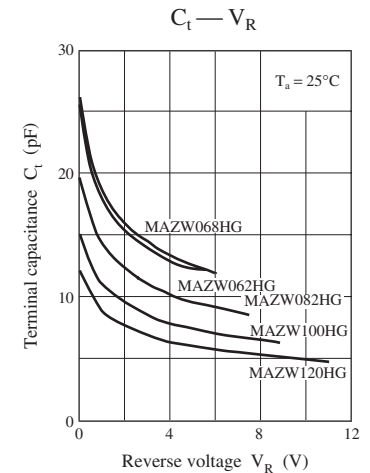
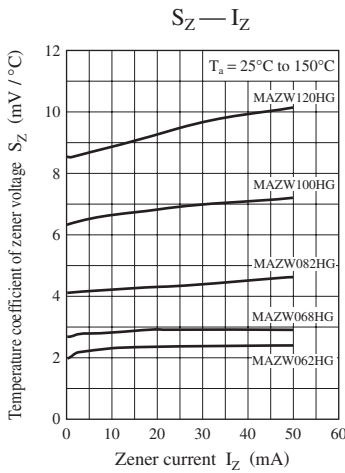
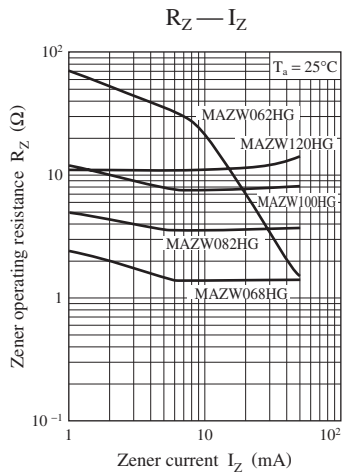
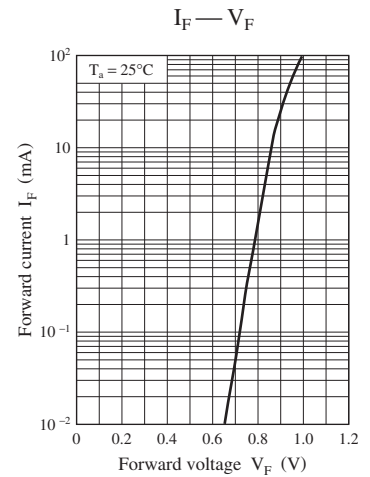
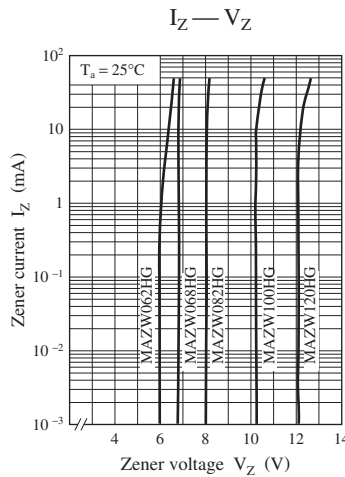
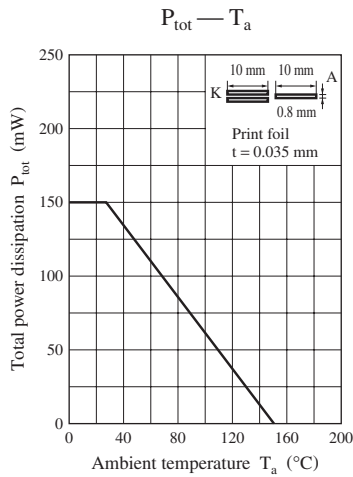

SSSMini3-F2

Unit: mm

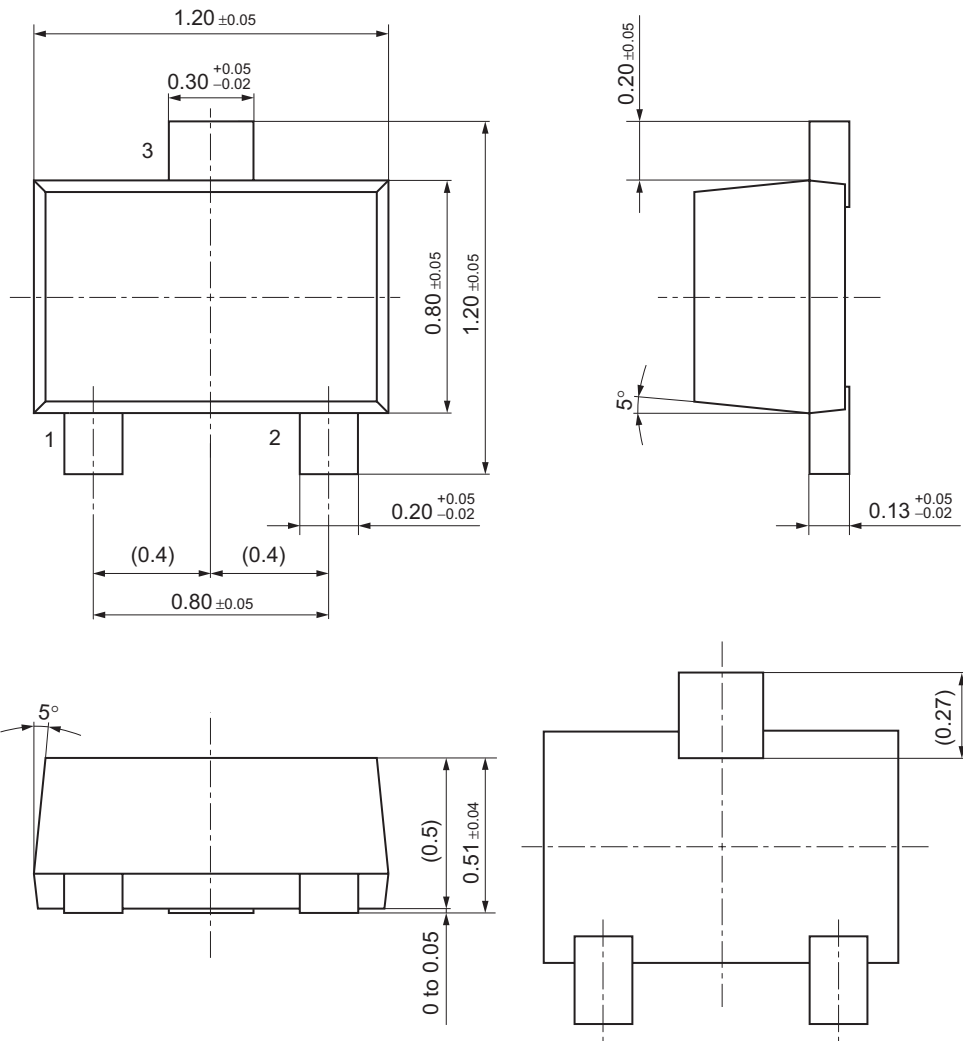

Request for your special attention and precautions in using the technical information and semiconductors described in this book

- (1) If any of the products or technical information described in this book is to be exported or provided to non-residents, the laws and regulations of the exporting country, especially, those with regard to security export control, must be observed.
- (2) The technical information described in this book is intended only to show the main characteristics and application circuit examples of the products, and no license is granted under any intellectual property right or other right owned by our company or any other company. Therefore, no responsibility is assumed by our company as to the infringement upon any such right owned by any other company which may arise as a result of the use of technical information described in this book.
- (3) The products described in this book are intended to be used for standard applications or general electronic equipment (such as office equipment, communications equipment, measuring instruments and household appliances).
Consult our sales staff in advance for information on the following applications:
 - Special applications (such as for airplanes, aerospace, automobiles, traffic control equipment, combustion equipment, life support systems and safety devices) in which exceptional quality and reliability are required, or if the failure or malfunction of the products may directly jeopardize life or harm the human body.
 - Any applications other than the standard applications intended.
- (4) The products and product specifications described in this book are subject to change without notice for modification and/or improvement. At the final stage of your design, purchasing, or use of the products, therefore, ask for the most up-to-date Product Standards in advance to make sure that the latest specifications satisfy your requirements.
- (5) When designing your equipment, comply with the range of absolute maximum rating and the guaranteed operating conditions (operating power supply voltage and operating environment etc.). Especially, please be careful not to exceed the range of absolute maximum rating on the transient state, such as power-on, power-off and mode-switching. Otherwise, we will not be liable for any defect which may arise later in your equipment.
 - Even when the products are used within the guaranteed values, take into the consideration of incidence of break down and failure mode, possible to occur to semiconductor products. Measures on the systems such as redundant design, arresting the spread of fire or preventing glitch are recommended in order to prevent physical injury, fire, social damages, for example, by using the products.
- (6) Comply with the instructions for use in order to prevent breakdown and characteristics change due to external factors (ESD, EOS, thermal stress and mechanical stress) at the time of handling, mounting or at customer's process. When using products for which damp-proof packing is required, satisfy the conditions, such as shelf life and the elapsed time since first opening the packages.
- (7) This book may be not reprinted or reproduced whether wholly or partially, without the prior written permission of Matsushita Electric Industrial Co., Ltd.